

**DRS & RRS
10AMP, 30AMP & 63AMP
DUAL REDUNDANT SWITCHES**

- 1. INTRODUCTION 3
 - 1.2. On Receipt Of The System..... 3
 - 1.3. Contents 3
 - 1.4. Storage 3
 - 1.5. Rating Plate 3
- 2. INSTALLATION 3
 - 2.1. Positioning 3
 - 2.6. Electrical Configuration..... 4
 - 2.7. Safety Precautions 4
 - 2.8. UPS Connection 4
 - 2.9. Output/ Load Connection (not RRS30/01 or RRS63J) 4
- 3. Front Panel (not RRS30/01) 5
- 4. OPERATION. 5
 - 4.1. Start up of the System 5
 - 4.2. Switch off 5
 - 4.3 Transfer to UPS 2..... 5
 - 4.4 Transfer DRS 63/02..... **Error! Bookmark not defined.**
 - 4.5 RRS30/01, /02 & RRS63J, /02 6
 - 4.6 RRS30/02 & RRS63/02 **Error! Bookmark not defined.**
- 5. ALARMS - WHAT TO DO..... 6
- 6. SPECIFICATIONS..... 6
- 7. DRS10 MOUNTING DIAGRAM..... 7
- 8. DRS30/63 MOUNTING DIAGRAM..... 8
- 9. RRS10 MOUNTING DIAGRAM..... 9
- 10. RRS30/63 DIAGRAM 10

1. INTRODUCTION

This manual contains detailed information on the installation and operation of your Dual Redundant Switch (DRS) and Rackmount Redundant Switch (RRS). Please read and follow carefully the instructions described in the following pages. Maximum rating of the DRS10/RRS10 is 10Amps, DRS30/RRS30 is 32Amps and for the RRS 63J is 63Amps. The DRS/RRS monitors two supplies, one master and one stand-by, if the master fails the module automatically switches to the stand-by. A key switch (1) where fitted allows the unit to be left in either AUTO or locked on to the stand-by supply for testing purposes. Some models have a three position key switch so that the load can lock on to master or standby.

- ◆ Models may have dual outputs as well as inputs. In the event of one of the supplies failing both loads are transferred to the remaining supply.
- ◆ The dual outputs combined MUST NOT EXCEED the total unit rating

NOTE: ENSURE BOTH SUPPLIES ARE IN PHASE. (DO NOT USE separate phases to supply a standard unit, if switching between out of phase supplies is required specially designed units are available)

1.2. On Receipt Of The System

The DRS/RRS packing is composed of a cardboard box and internal plastic packing. On receipt of the DRS/RRS, carefully inspect the packing for any signs of damage. If damage is evident, please notify the forwarder immediately.

1.3. Contents

In addition to the DRS/RRS, the packing contains:

- 2 x Keys. (if key switch fitted)
- 1 x Installation and Operation Manual.
- 2 x IEC plug to IEC socket leads (if IEC plugs and sockets fitted).

1.4. Storage

If you plan to store the DRS/RRS prior to use, store it, packed if possible, in a room with an ambient temperature range within -10°C to +50°C and a humidity of less than 95%.

1.5. Rating Plate

The rating plate provides the model, serial No., voltage and current ratings for the DRS/RRS.

2. INSTALLATION

WARNING: ALL THE OPERATIONS IN THIS SECTION MUST BE PERFORMED BY AUTHORISED AND QUALIFIED PERSONNEL.

The Company will take no responsibility for any personal injury or material damage caused by not following the instructions in this manual and/or poor on-site workmanship.

2.1. Positioning

The DRS is designed as a wall mounted unit.

Please ensure that the final site position for the DRS provides:

- Easy access for maintenance, in a dust free, well ventilated site, within the temperature and humidity limits described.
- No direct exposure to heat generating sources or direct sunlight.
- See diagrams (7 & 8) for dimensions and fixings.

The RRS is designed as a 19inch rack mount unit 3U high (diagrams 9 & 10).

2.6. Electrical Configuration

Both live and neutral are switched in the operation of these units.

2.7. Safety Precautions

This DRS/RRS is designed for use as described in this manual and extreme caution should be used if it is to be used for any other purpose.

2.8. Supply Connection

Before you start to connect the DRS/RRS make sure that:

- ◆ The operating voltage and frequency match the values indicated on the rating plate of the DRS/RRS.
- ◆ The earthing efficiency is in accordance with the IEC Standards.
- ◆ Cables connecting the output of the two supplies and the load to the DRS/RRS should be of the size suitable for the applied load.
- ◆ Both of the supplies connected to the DRS/RRS are on the same phase.

WARNING: PLEASE ENSURE THAT THE MAINS SUPPLY IS SWITCHED OFF AND THE LOAD IS DISCONNECTED.

IF ONE OR BOTH OF THE SUPPLIES IS A UPS ENSURE IT IS COMPLETELY SWITCHED OFF BEFORE COMMENCING WORK. REFER TO UPS OPERATING MANUAL

- ◆ DRS/RRS fitted with external IEC plug and sockets Use IEC to IEC leads to make connections to the supplies.
- ◆ DRS/RRS fitted with external Industrial plugs and sockets. Use in lead or wall mount industrial connectors.
- ◆ DRS with terminals remove the cover by removing the four No.6 ½inch self-tapping screws.
- ◆ RRS with terminals remove the terminal block cover by removing the four M4 screws.
- ◆ Feed cables through appropriate cable gland.
- ◆ The master supply connects to terminals Master Live, Neutral and Earth
- ◆ The standby supply connects to Standby Live, Neutral and Earth.
- ◆ Refit cover.

2.9. Output/ Load Connection

Before starting please ensure that:

- ◆ The DRS/RRS rated power written on the rating plate is equal or greater than the total load requirement.
- ◆ The total load does not exceed the maximum rating for a single supply. (if one or both supplies is a UPS ensure UPS rating exceeds total load.Refer to UPS manual.)
- ◆ Units with 4 x IEC connectors for attaching the loads. Total load must not exceed 10Amps.
- ◆ Where the output line is protected with a 2-pole circuit breaker, it has B characteristics complying with the IEC Standards, and is of rated power adequate for the load. If there is more than one load, it is recommended to provide an output distribution board with separate circuit breakers for each load.
- ◆ On the output distribution board should be indicated the following:
 - ◆ Maximum total load rating
 - ◆ Maximum load rating of the load sockets.

NOTE: Where two separate supply circuits are present, it is recommended that each socket supplied from is marked with its source, to avoid unauthorised loads being connected to the system.

The cable used for the connection should be flexible and with minimum section suitable for the total load.

- ◆ Remove the cover of the DRS by removing the four No.6 ½inch self-tapping screws.
- ◆ Remove the terminal block cover of the RRS by removed the four M4 screws.
- ◆ Feed cables through appropriate cable gland (3).
- ◆ The load connections are Load Live, Neutral and Earth.
- ◆ Refit cover.

NOTE: Units with two outputs may also have separate fusing fitted for each output

3. Front Panel

Two position Key switch Fitted:

The key switch (1) has two positions 'AUTO' and 'Supply 2/Standby', this is used to lock the DRS/RRS on to Supply 2 so that testing or servicing can be carried out on Master supply without interruption to the load. In the auto position the load will be supported by the master supply unless it's output fails or is switched off.

The DRS/RRS front panel includes a neon status indicator (2), this lights when the load is being supplied by standby due to a fault on master supply, master being switched off or the key switch is in Supply 2 /Standby position.

Three position Key switch fitted:

The three position key switch so that the loads can be locked to either supply 1 or 2, Left(1) is Supply 1, Centre(2) Auto. Right (3) Supply 2.

NOTE: With the change over switch in the Supply 2/standby position your load will be dropped in the event of the output from Supply 2 failing due to a fault or the unit being switched off.

4. OPERATION.

4.1. Start up of the System

- ◆ Make sure all the connections have been performed correctly.
- ◆ Make sure all the loads are disconnected.
- ◆ Ensure key switch (1) is in the AUTO position.
- ◆ Switch on the master supply.
- ◆ Switch on the standby supply.

The system is now ready to accept the load.

4.2. Switch off

If the master supply is switched off the load will be transferred to standby/supply 2. To prevent this switch standby off first.

4.3 Transfer to Standby/Supply2

Two position switch

To lock the load on to Standby/Supply 2 turn the change over switch (1) to the Standby/Supply 2 position. The load is now supported by the standby supply so that the master supply can be tested/maintained.

Three position switch

The centre position of the key switch is auto. Turn the key to the left to lock the loads onto input 1. Turn the key to the right to lock the load onto input 2.

In the event of the supply the unit is locked to failing or being switched off the load will be dropped.

4.4 Units with Industrial/Commando Plugs and Sockets fitted

At the rear of the unit there are four connectors.

Connect the two commando sockets to loads 1 & 2.

Connect the two commando plugs to your supply 1 & 2.

Switch on the supplies, both neons (5) & (6) on the front panel should glow.

Supply 1 is feeding load 1 and 2.

If either neon (5) or (6) go out the output feeding that load has failed. Each output has separate internal fuses.

If neon (7) or (8) goes out the associated supply has failed, or been switched off.

If supply 1 fails both loads will transfer to supply 2, once the failed supply returns the loads will transfer back.

NOTE: Before working on either load disconnect from the RRS or switch off/disconnect both supplies.

5. ALARMS - WHAT TO DO

In the event of a Master supply failure the load will be transferred to Standby/Supply 2 and the neon (2) will light. If this has occurred Master Supply should be checked, unless it has been switched off.

6. SPECIFICATIONS

- ◆ Operating Temperature 0°C - 40°C
- ◆ Storage Temperature -10°C - 50°C
- ◆ Relative max. humidity without condensate 95%
- ◆ Maximum operating altitude 1000m msl
- ◆ Acoustic noise, as measured at 1m from front of equipment (depending on load and temperature) dBA 48dBA (100% load)
43dBA (<50% load)
- ◆ Degree of protection IP20
- ◆ Cabinet colour RAL 7035
- ◆ Transfer time (Master supply failure) 6-8ms
- ◆ Reference norms SAFETY EN50091.1
EMC EN50091-2, A-level
IMMUNITY EN 61000-4 part 1,2,4,5
- ◆ Rated voltage 230Vac single phase (see rating plate)
110Vac single phase (see rating plate)
- ◆ Single phase input current max. 10A DRS/RRS10 (see rating plate)
32A DRS/RRS30J
32A RRS30/01 & /02
63A DRS/RRS63J
63A DRS63/01 & /02
- ◆ Frequency 50/60 Hz

7. DRS10 MOUNTING DIAGRAM

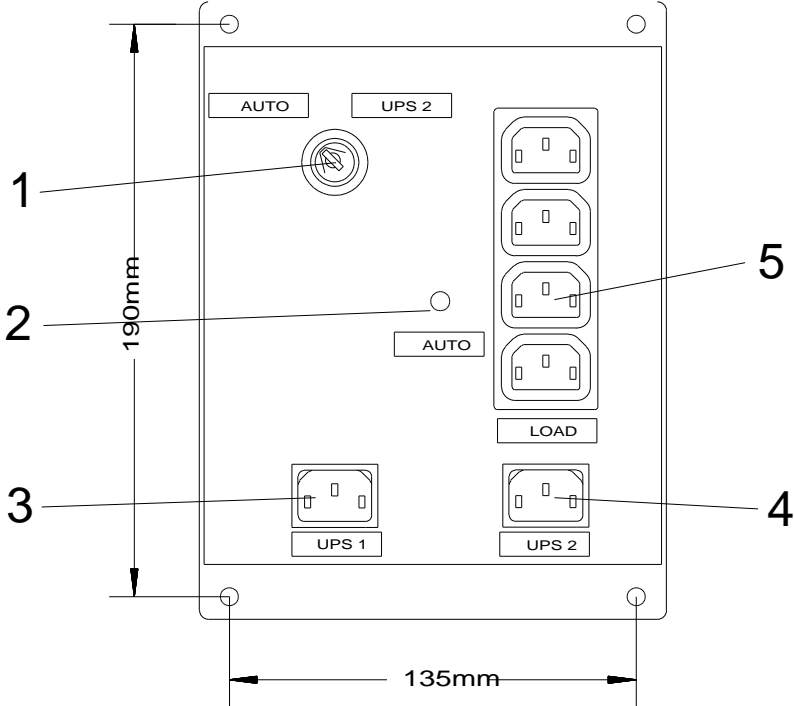

- 1. Keyswitch
- 2. Neon indicator
- 3. UPS 1 connector
- 4. UPS 2 connector
- 5. LOAD connector

DRS10J & DRS10/01

8. DRS30/63 MOUNTING DIAGRAM

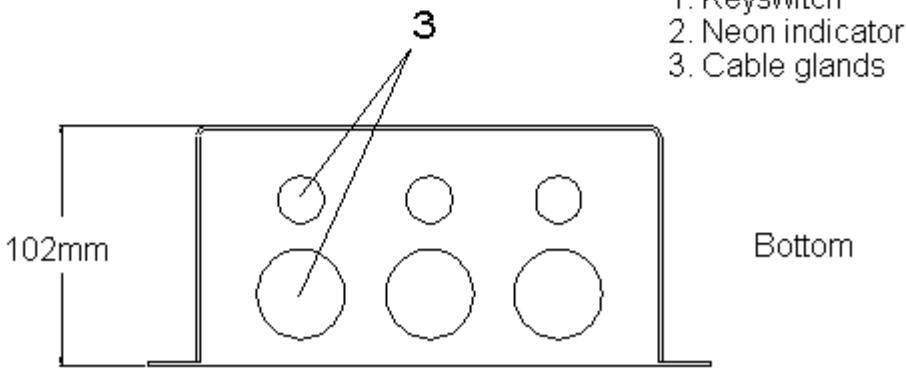
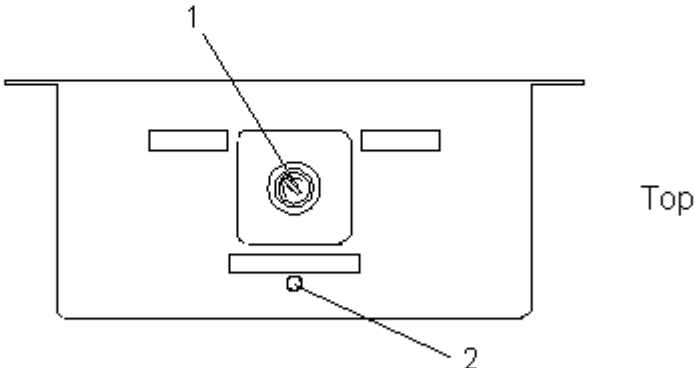
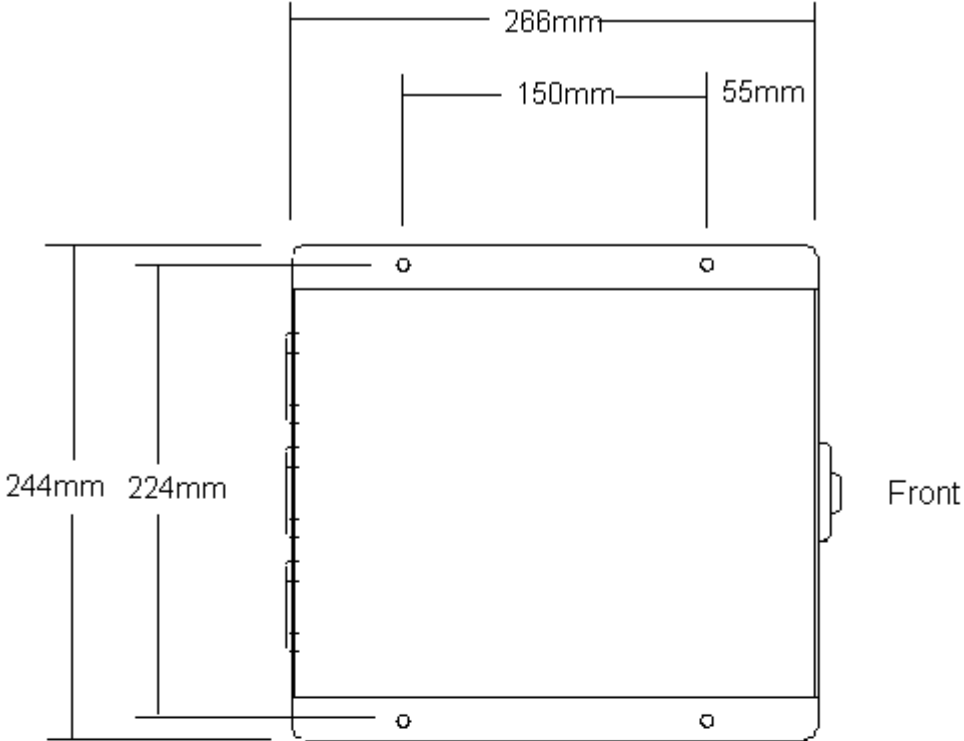

DRS 30/63

9. RRS10 MOUNTING DIAGRAM

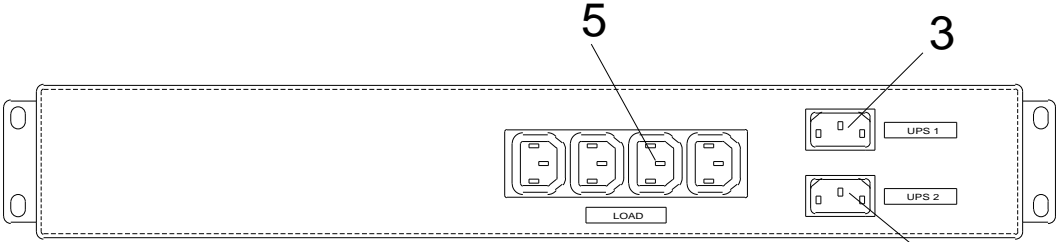
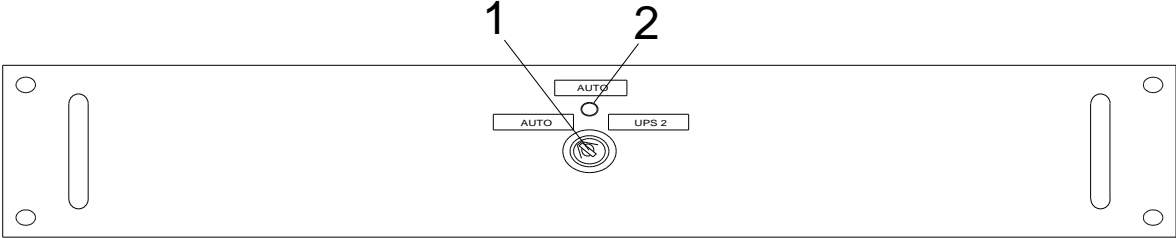

RRS10J & RRS10/01

- 1. Keyswitch
- 2. Neon indicator
- 3. UPS1
- 4. UPS2
- 5. LOAD

10. RRS30/63 DIAGRAM

FRONT VIEW

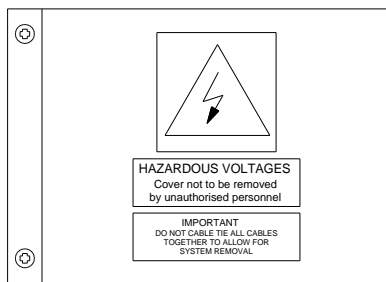
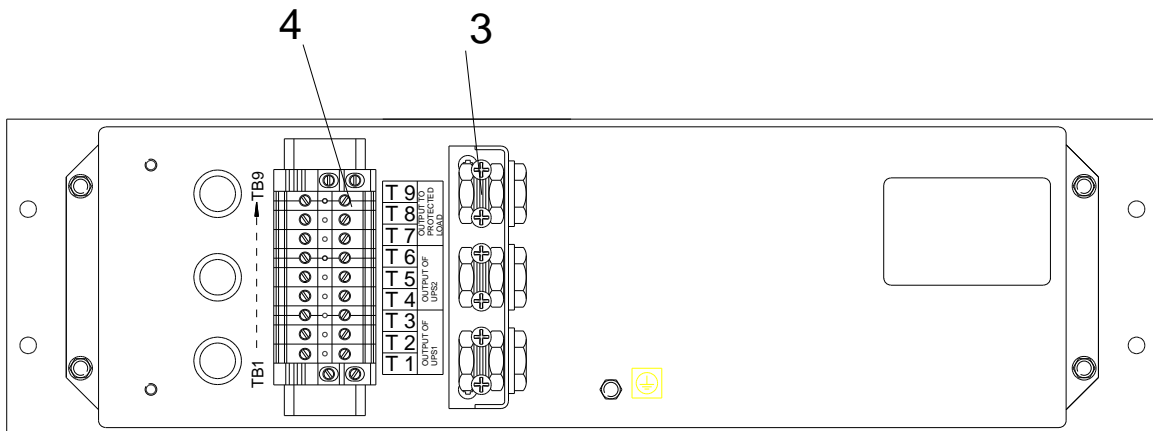
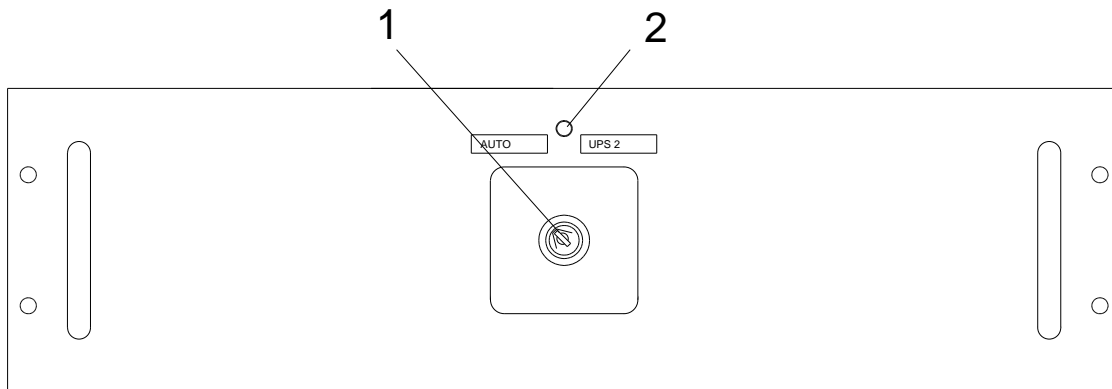

- 1. Keyswitch
- 2. Neon indicator
- 3. Cable glands
- 4. Terminal blocks

RRS30/RRS63